

Drum Circle Seating Charts

28 - 156 Persons in different set ups.
Very subject to change regarding individual needs.
Feel free to use. Be fair and quote.

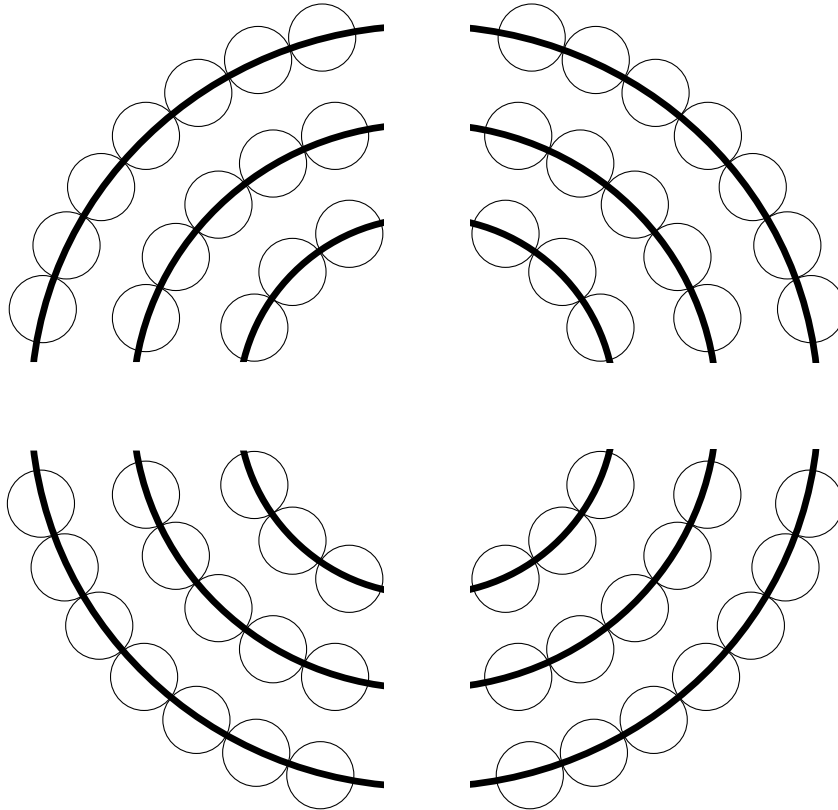

How to use this document

- Check which set up comes closest to your expected number of participants.
- Check where you can add or leave out chairs to fit your number exactly.
- Export the respective page as single document and send it to your client.
- Ask for the considered changes (remember b).

OR

Simply use this document for yourself and/or your clients as an inspiration about how a drum circle set up could look like.

© 2020 edited by

GEWA
DRUMCIRCLES
gewadrumsircles.com

Drum Circle 28 PAX

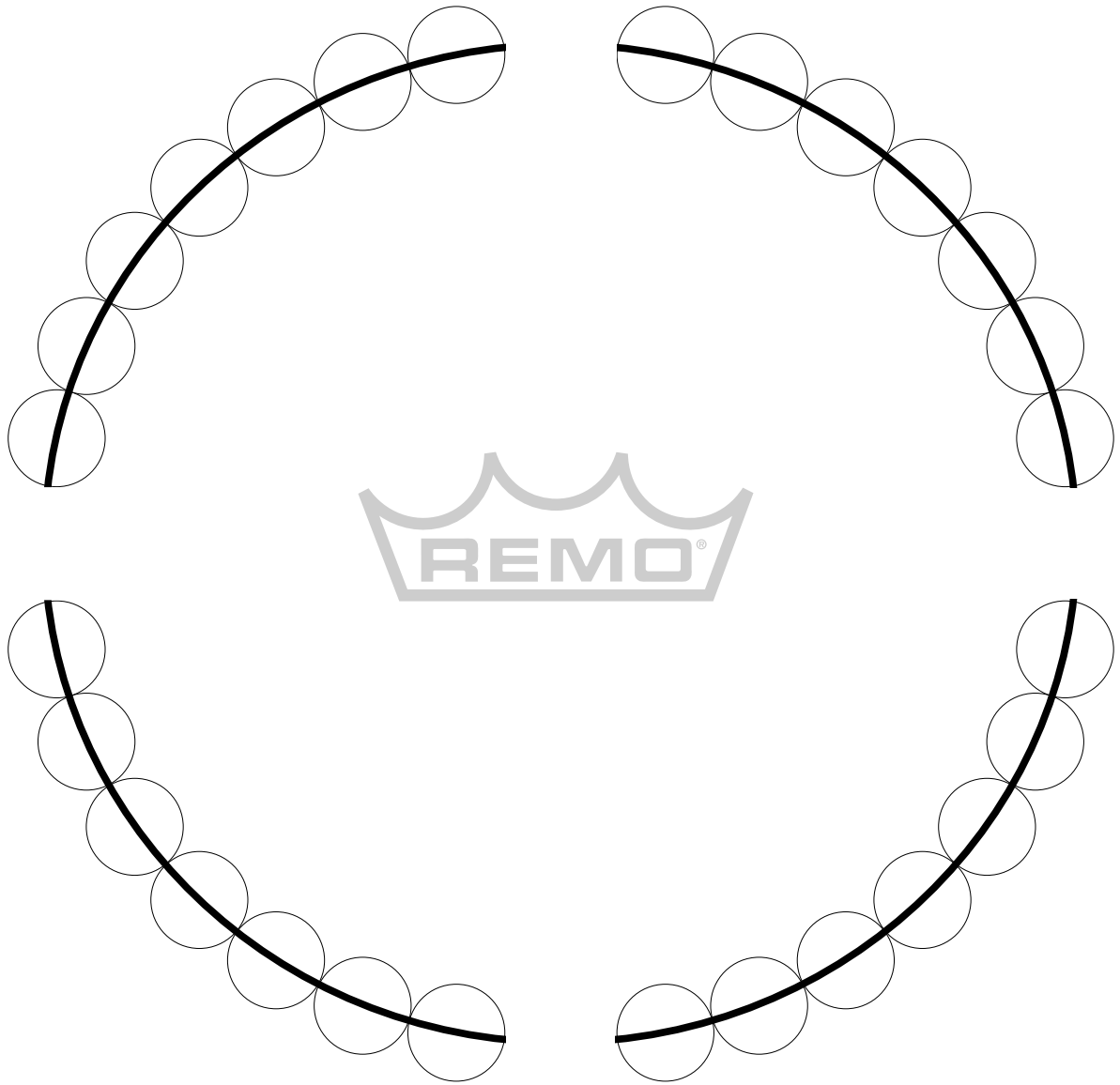

Drum Circle 33 PAX

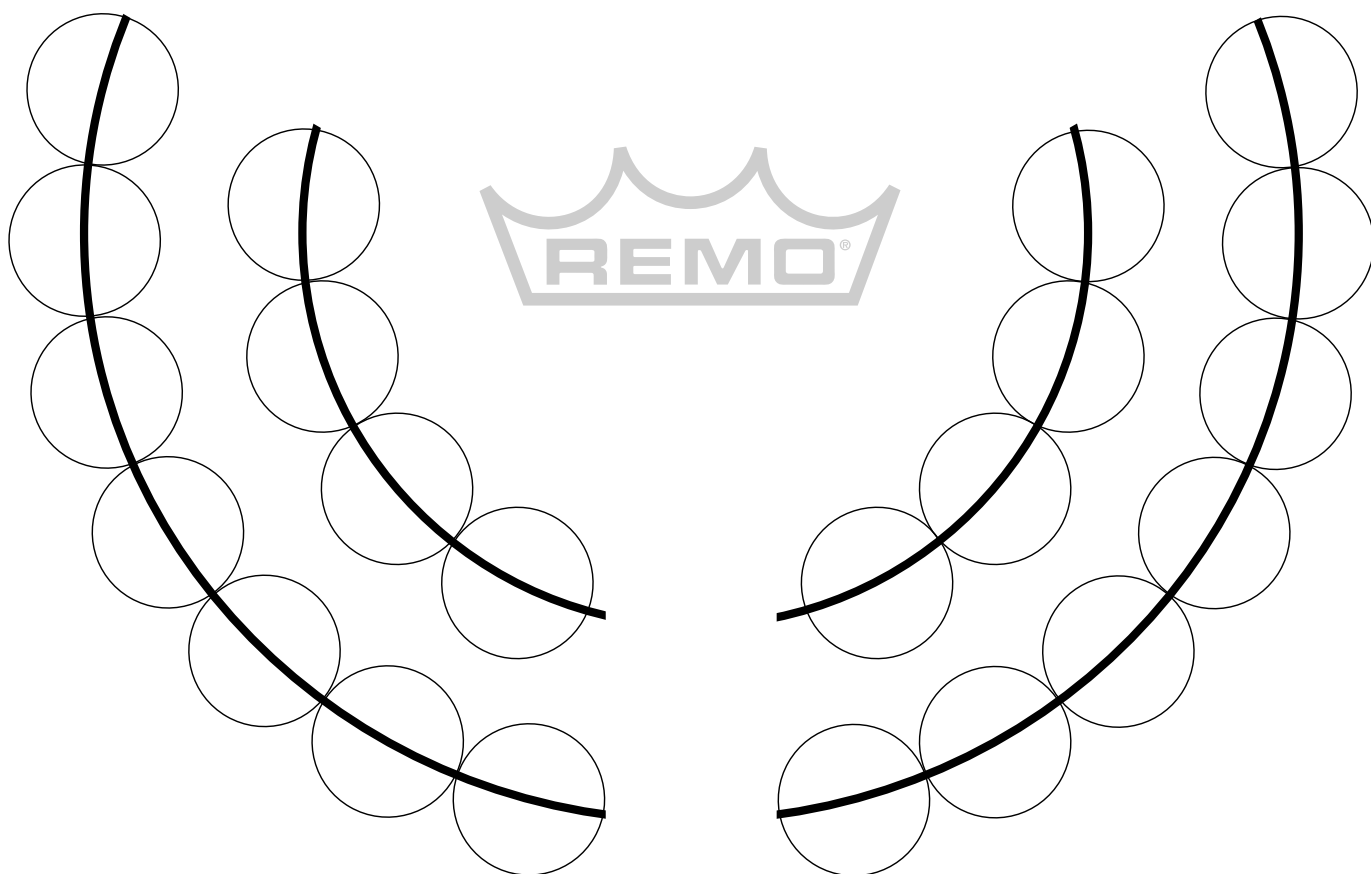
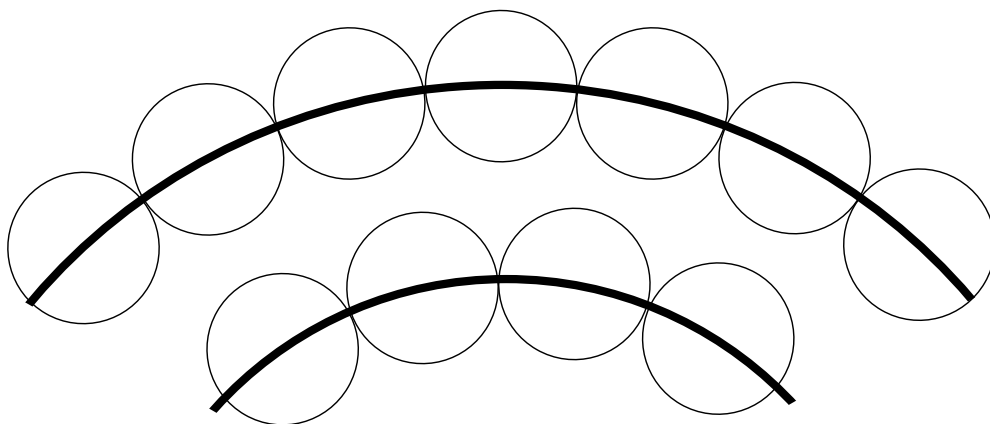

Drum Circle 39 PAX

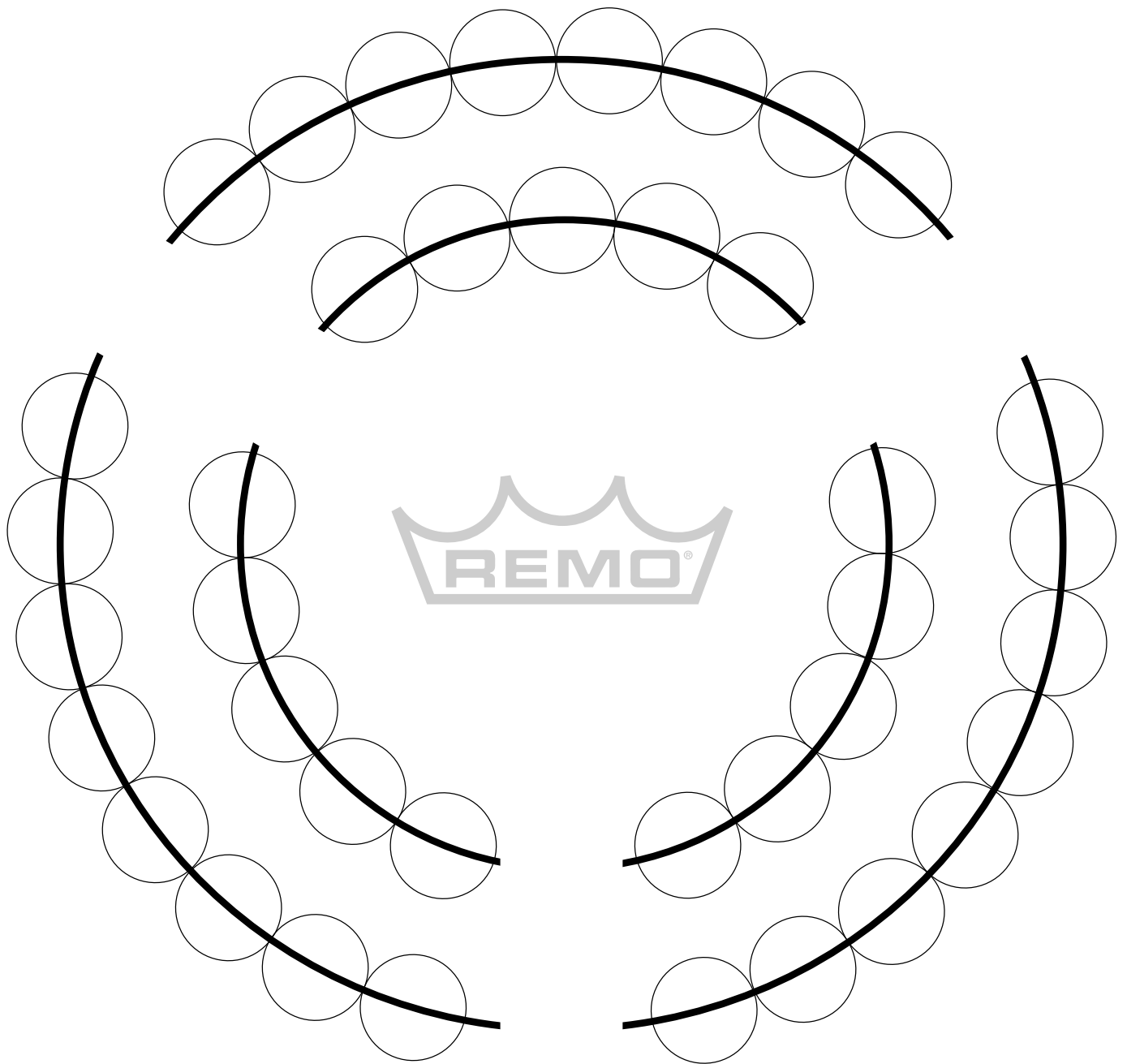

Drum Circle 40 PAX

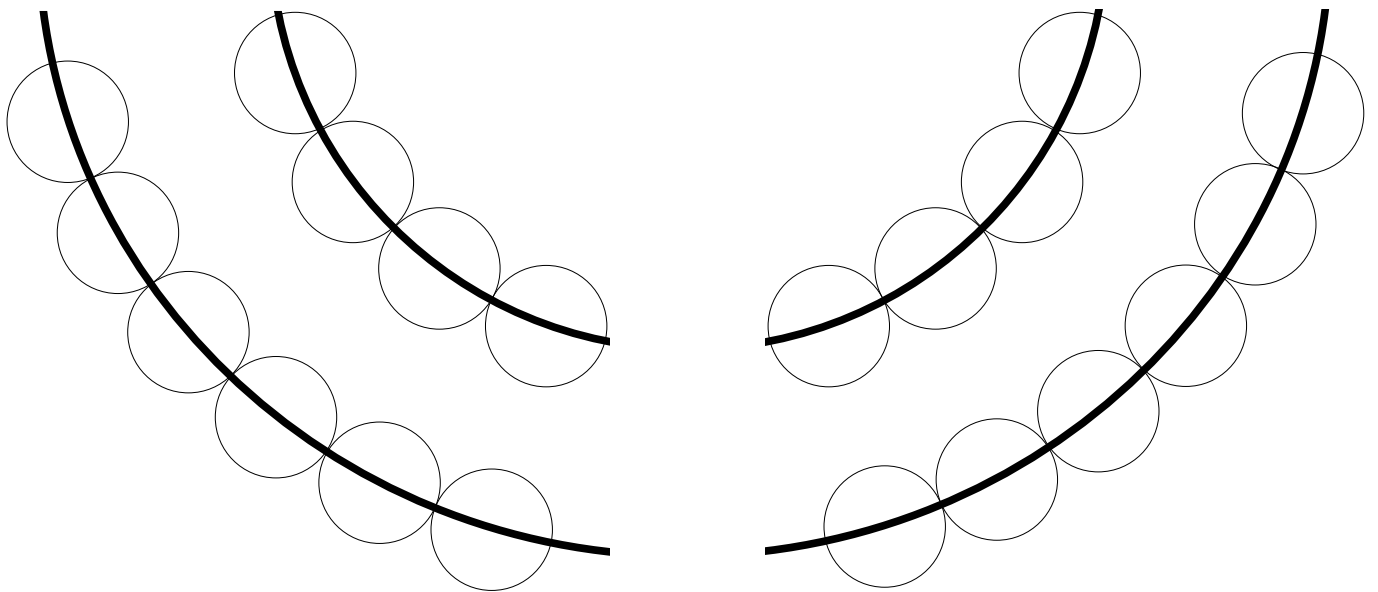
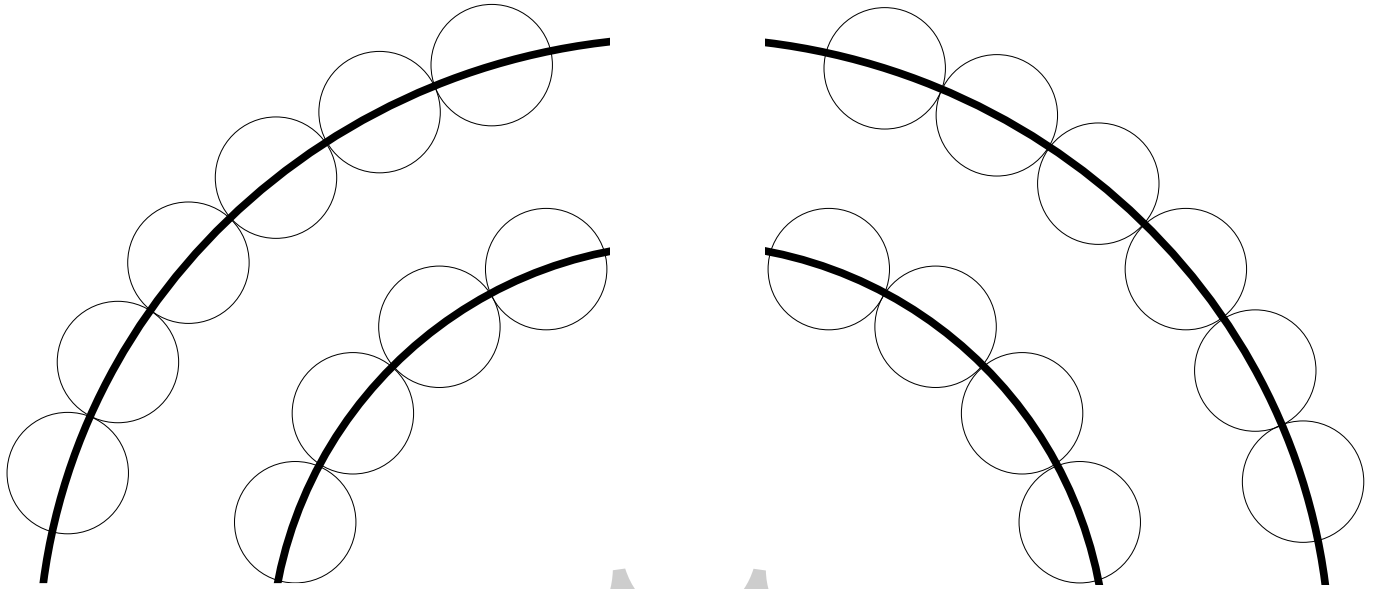

Drum Circle 44 PAX

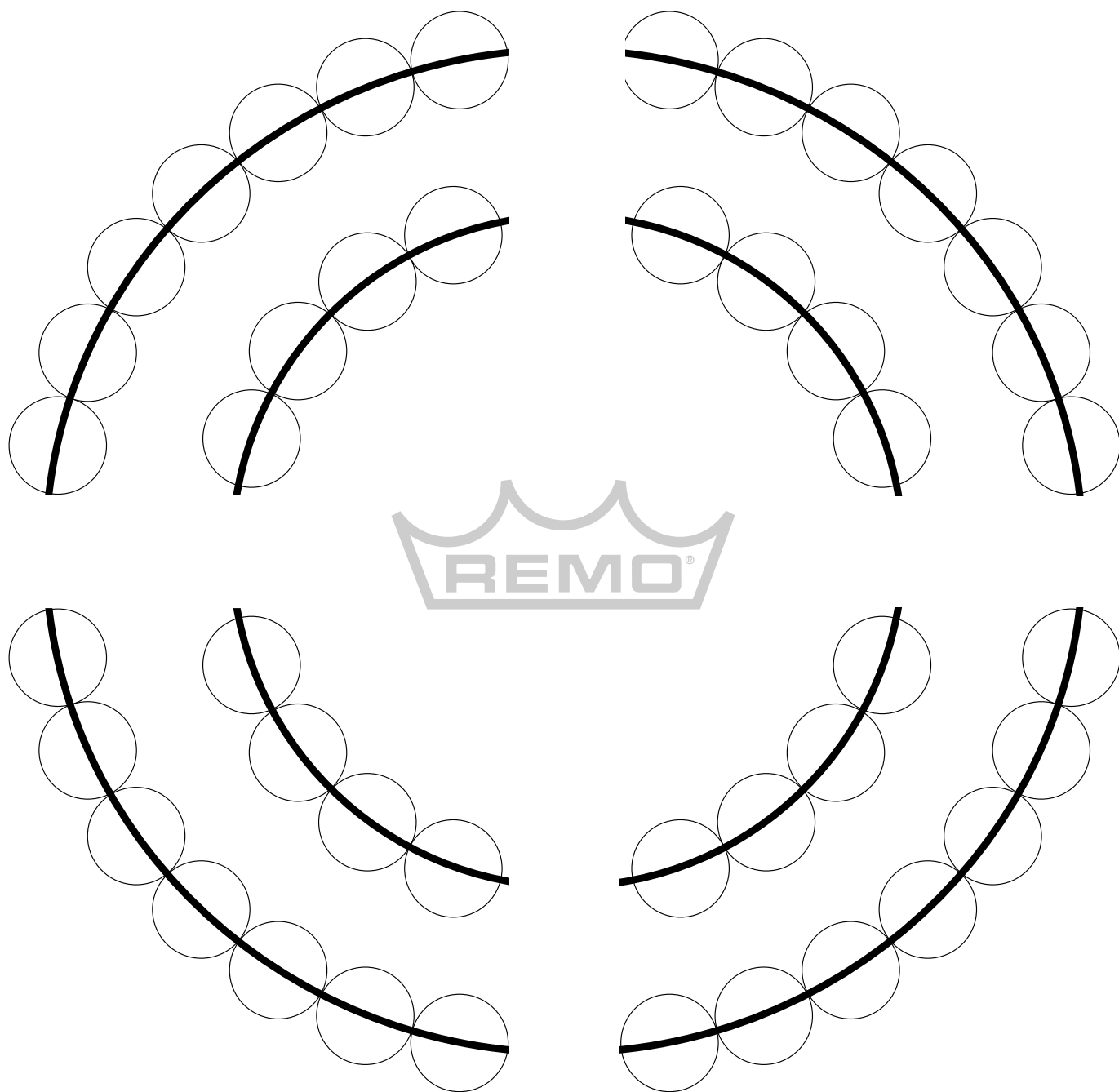

Drum Circle 52 PAX

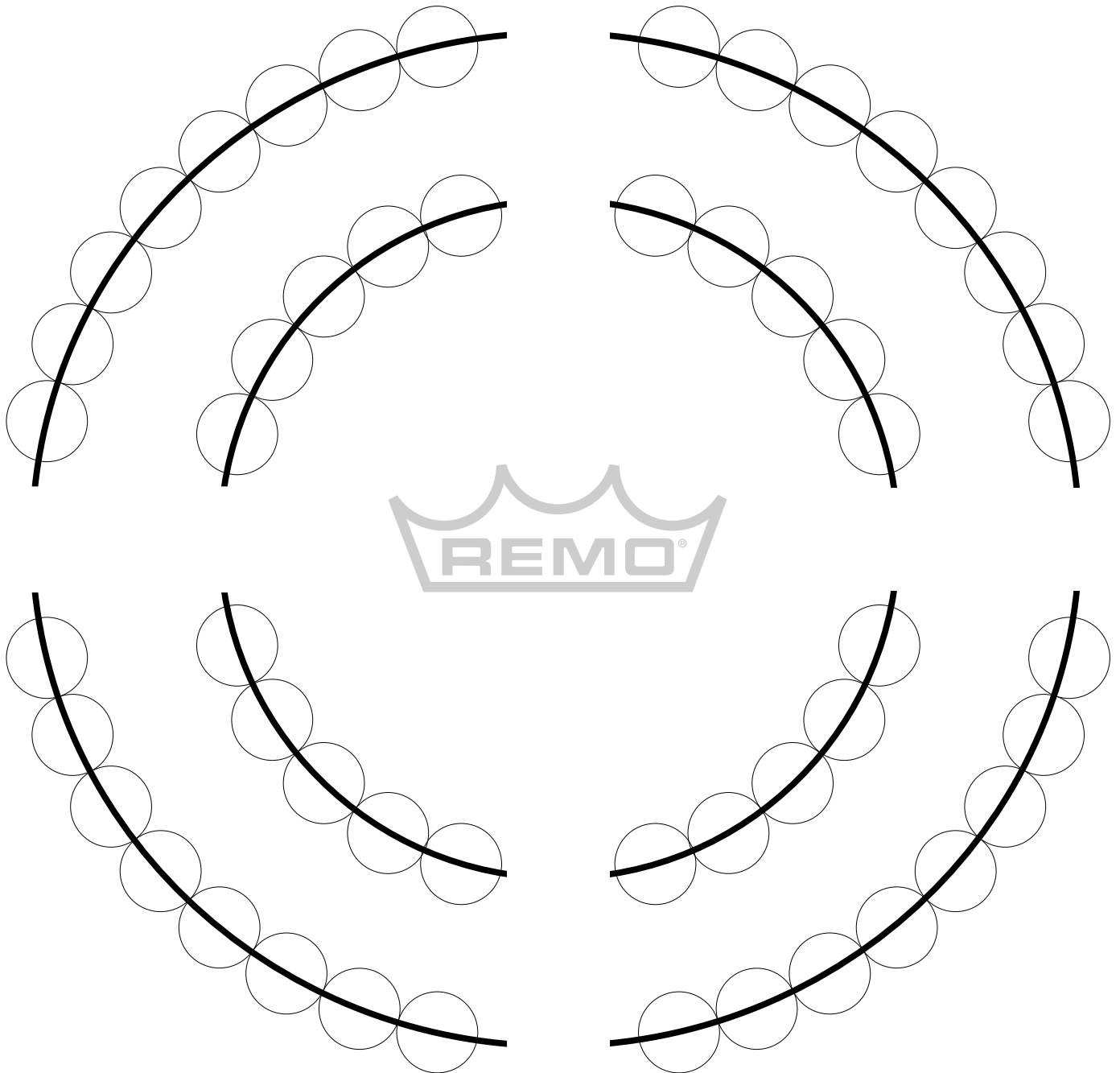

Drum Circle 60 PAX

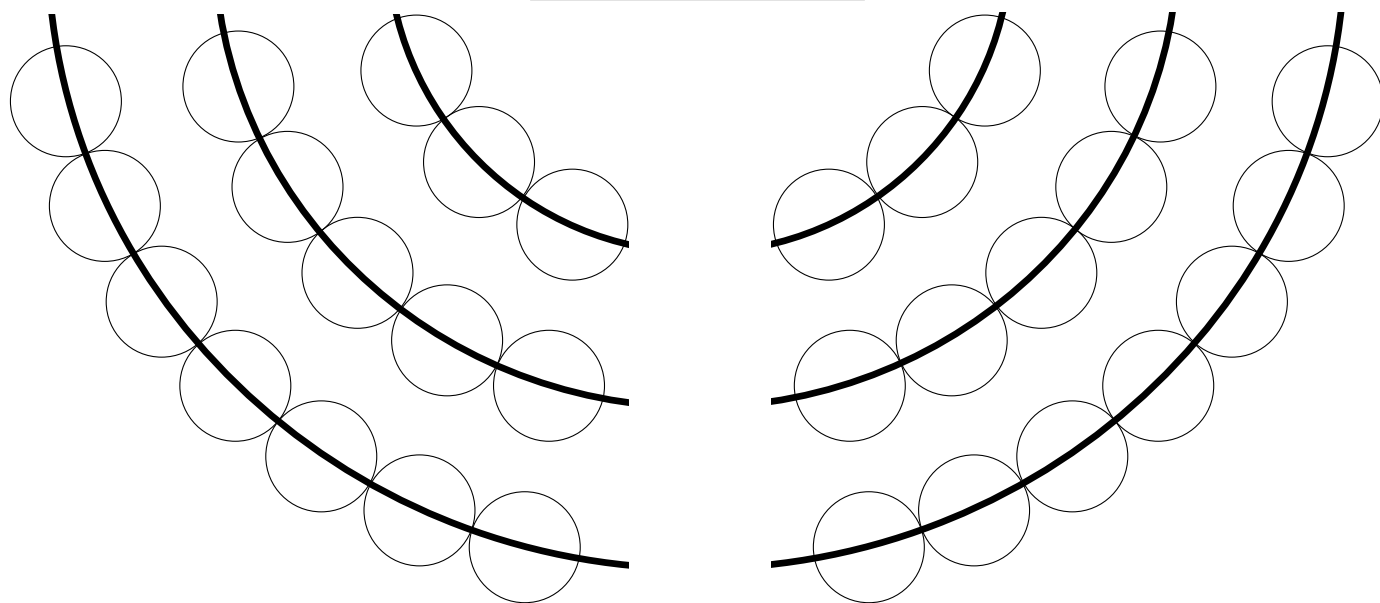
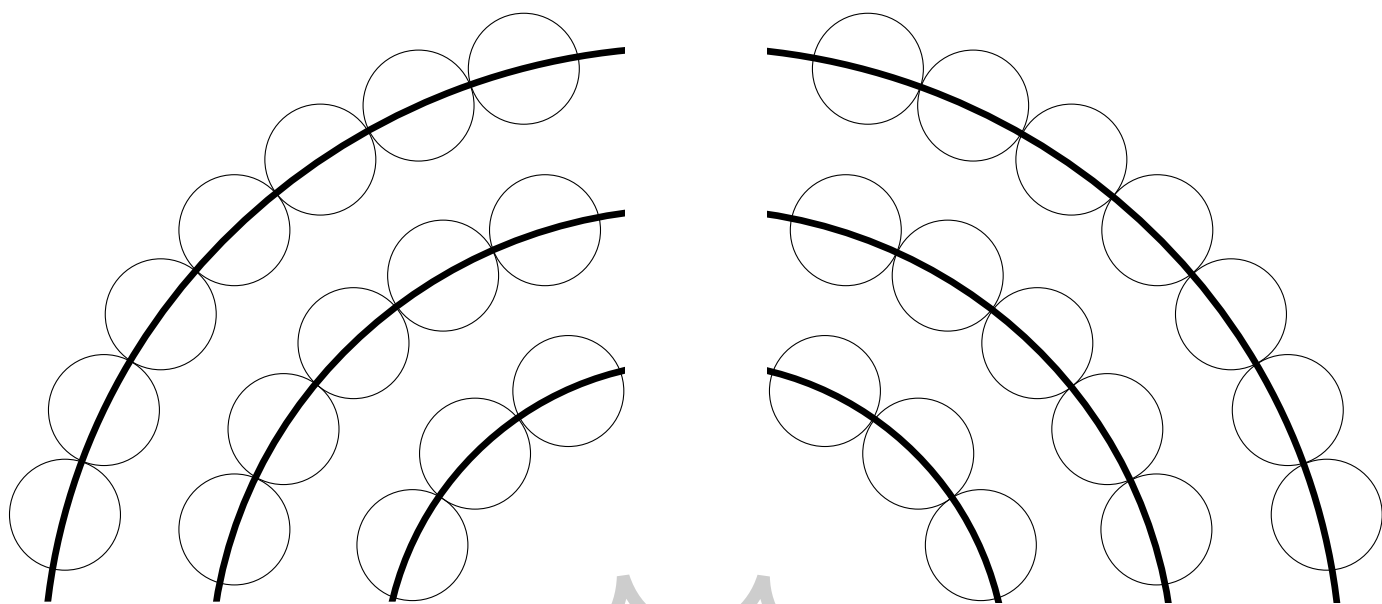

Drum Circle 64 PAX

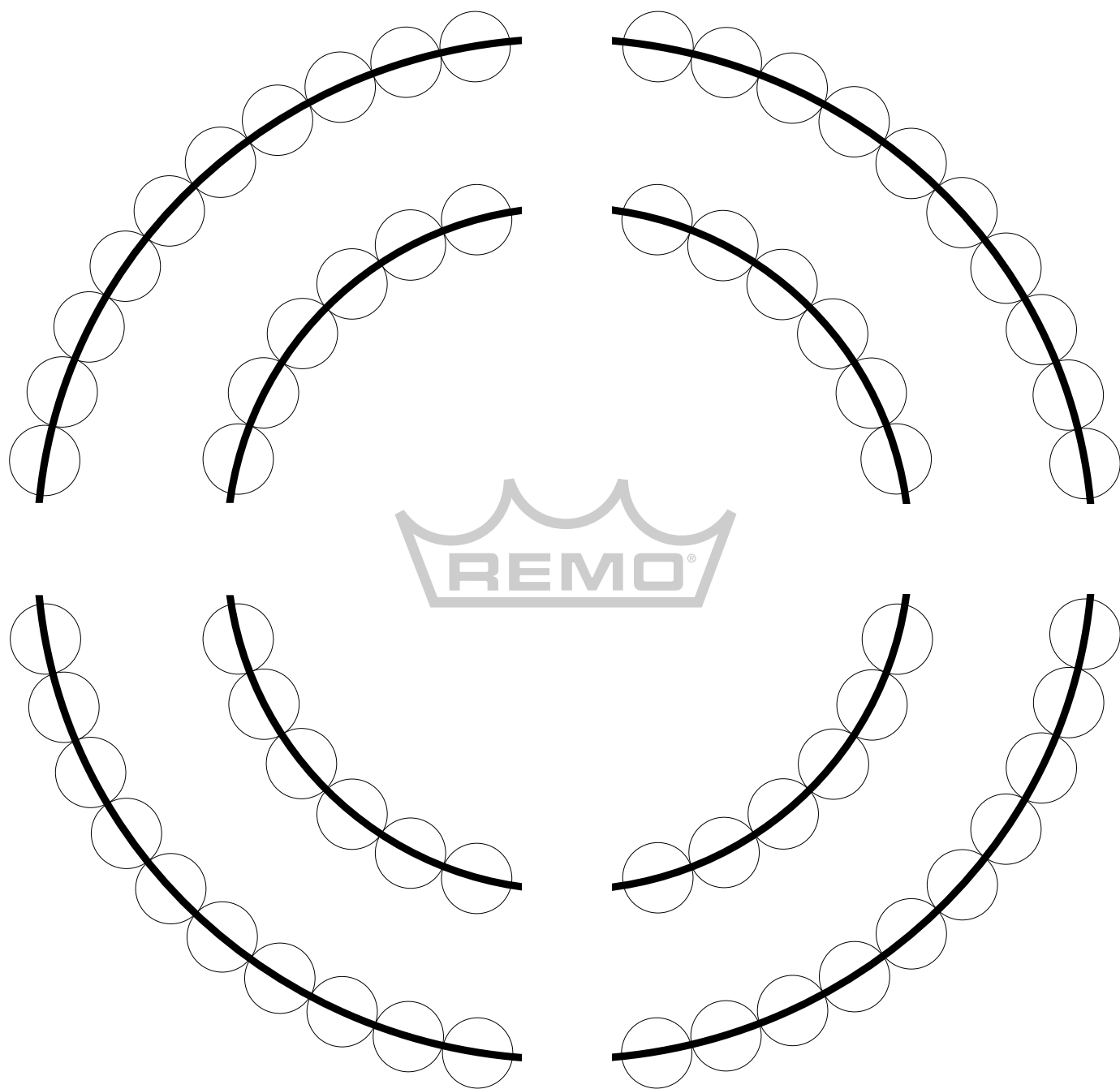

Drum Circle 66 PAX

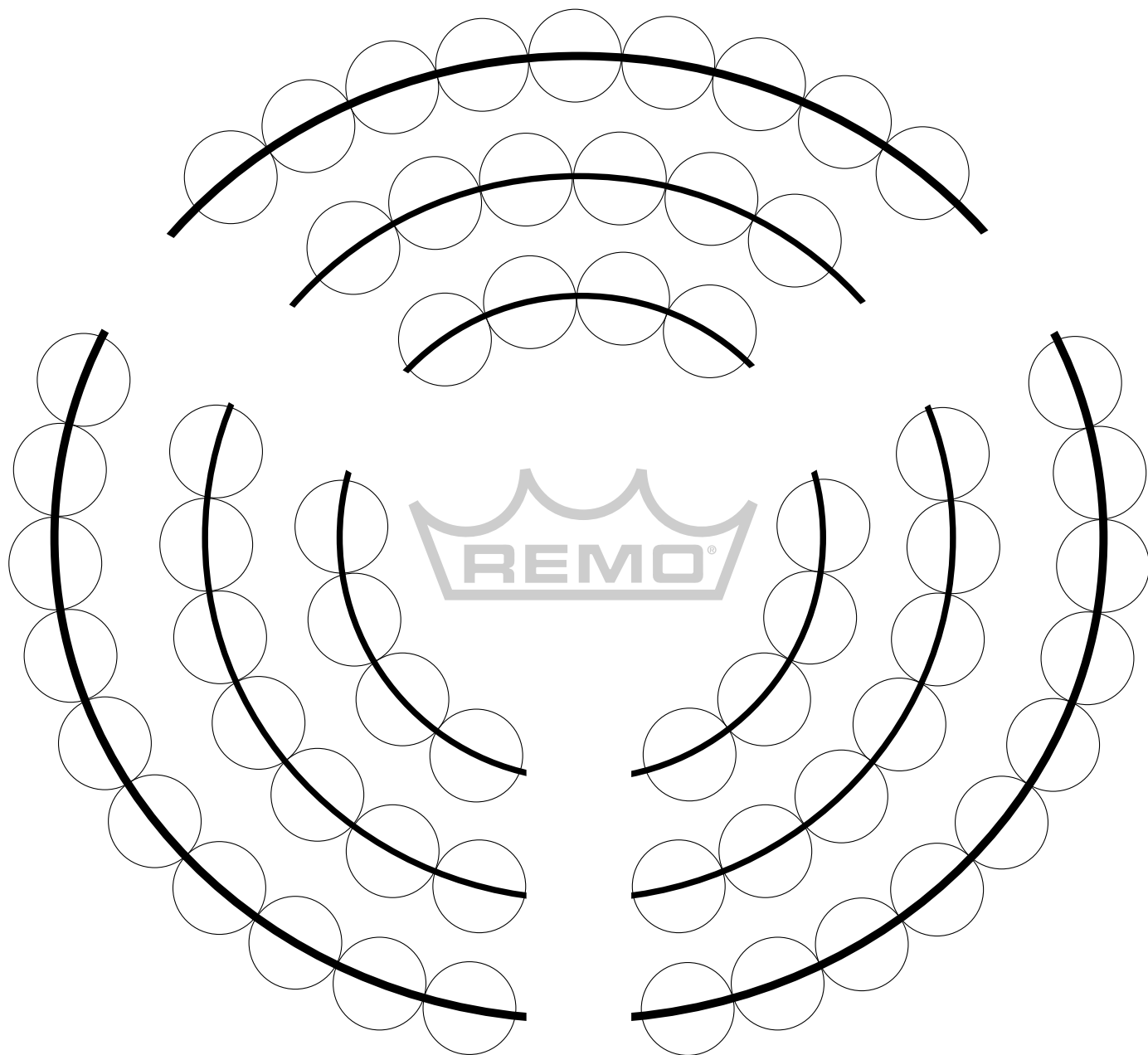

Drum Circle 72 PAX

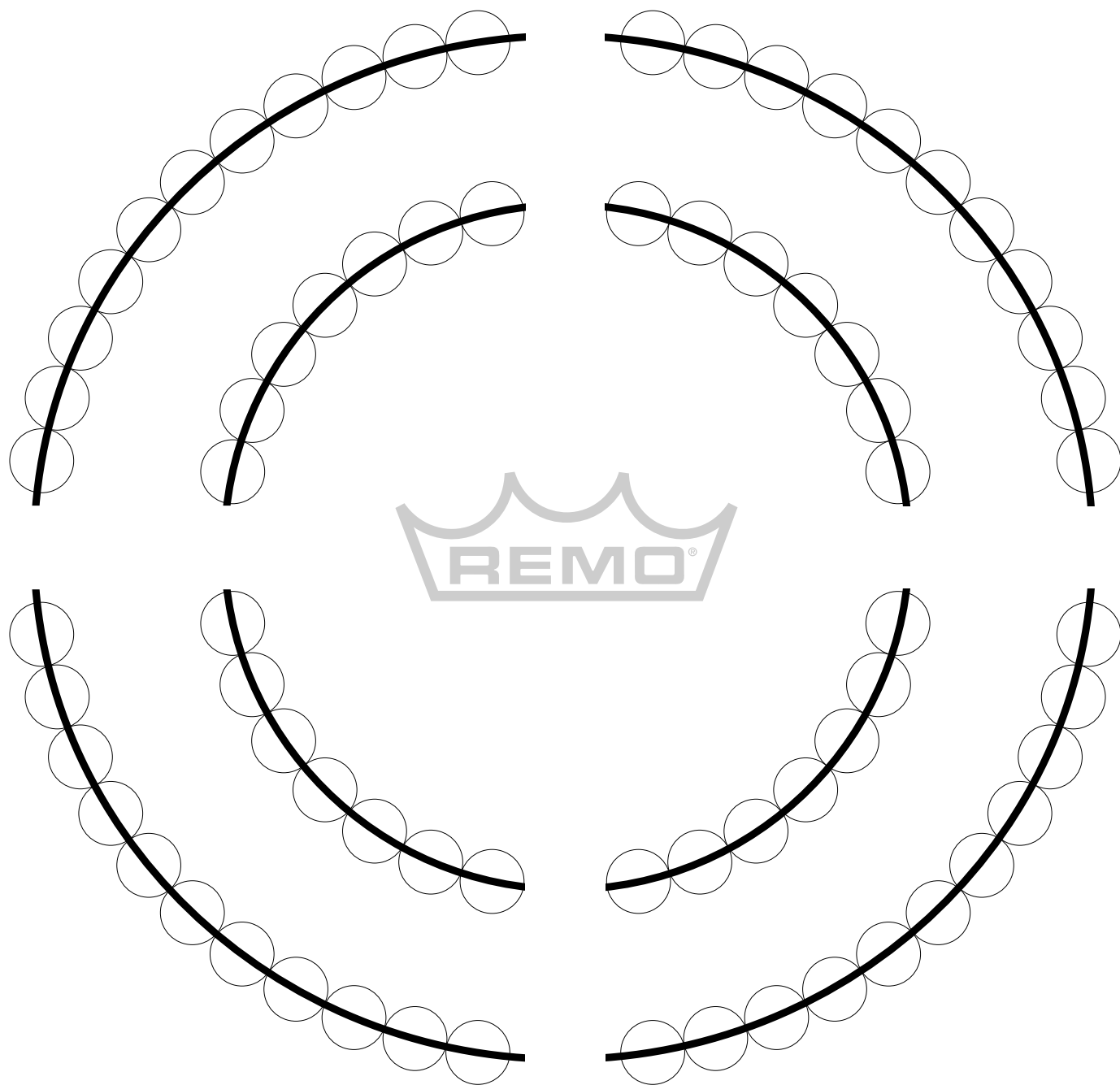

Drum Circle 72 PAX

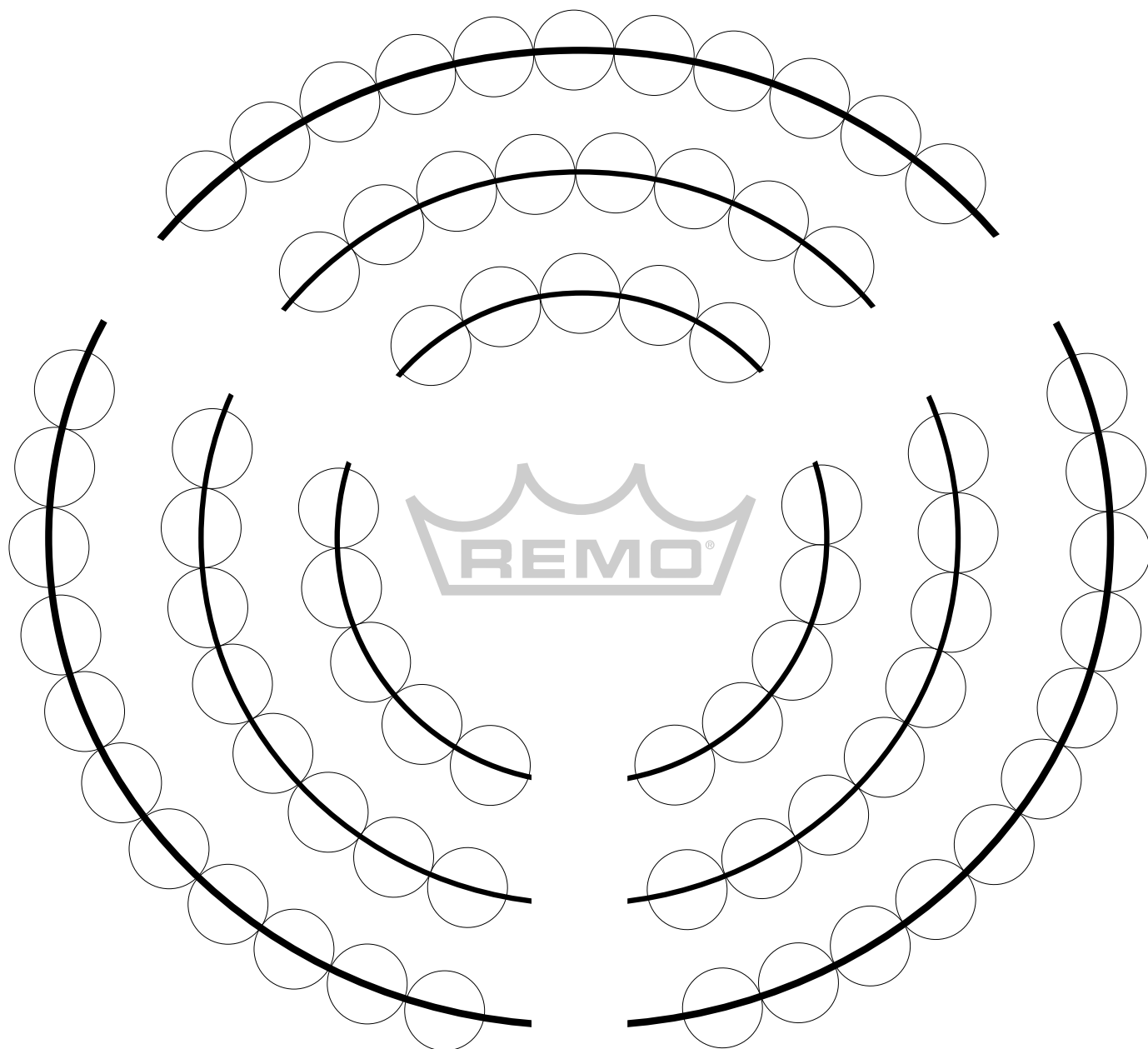

Drum Circle 76 PAX

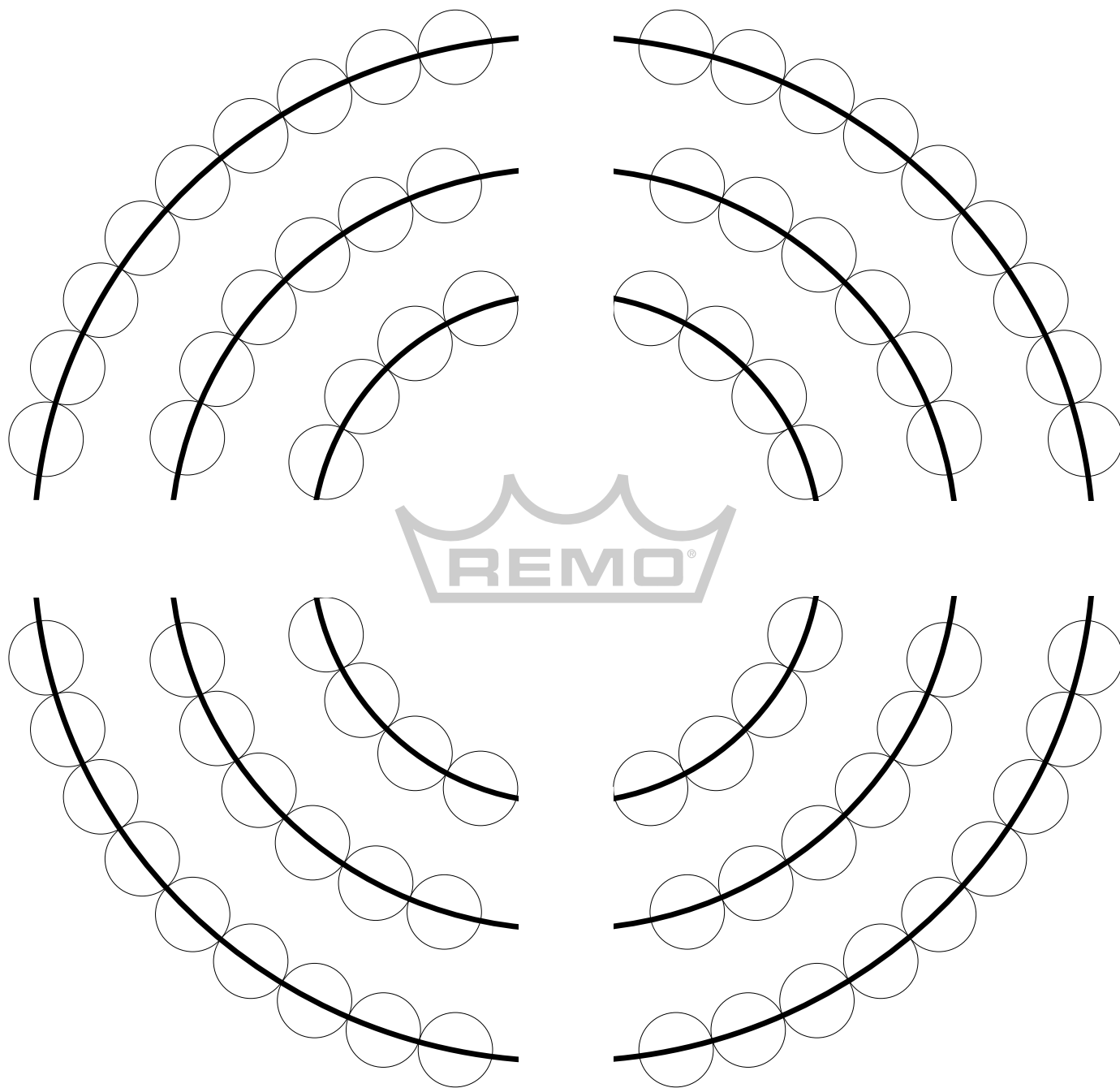

Drum Circle 96 PAX

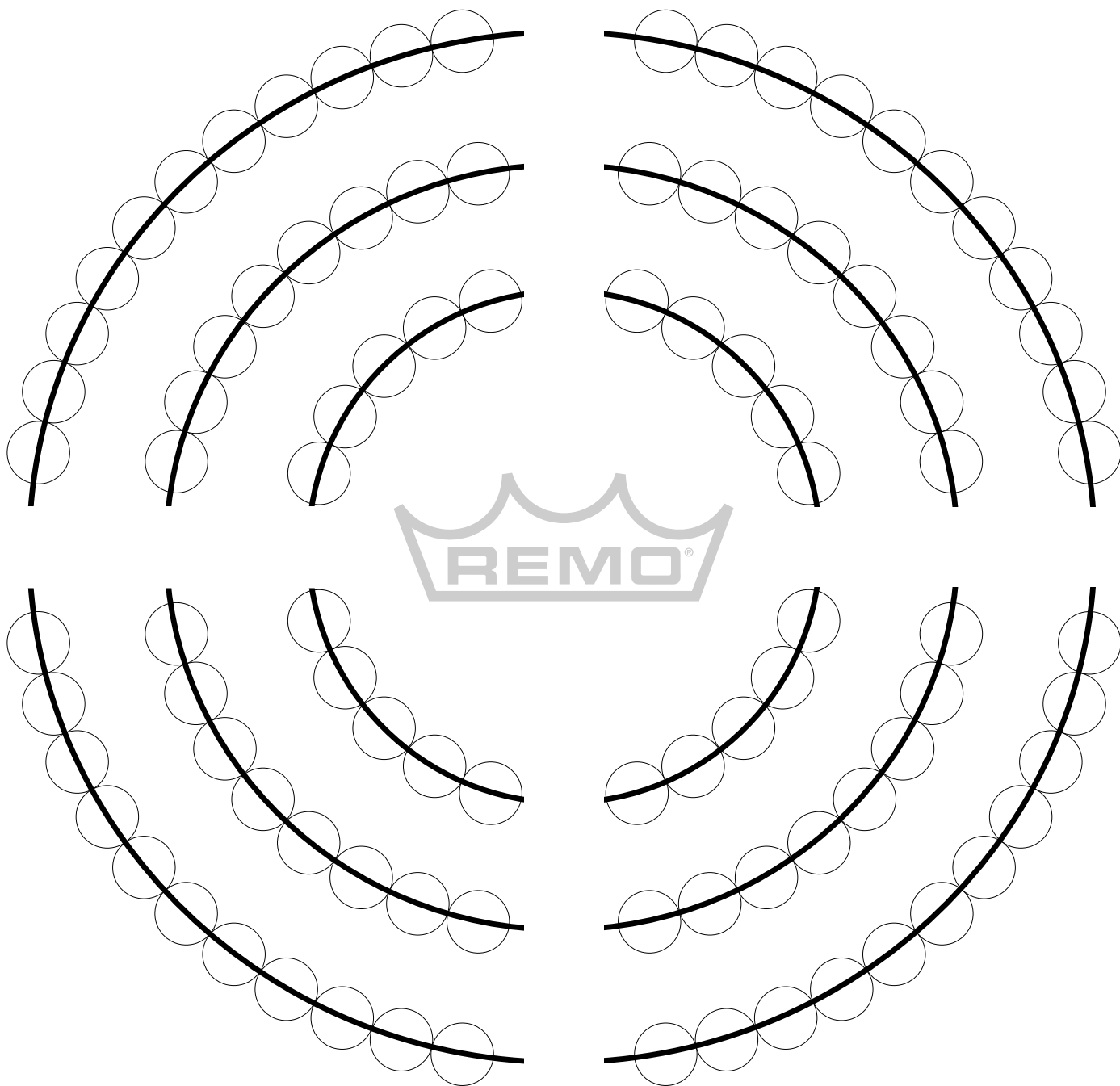

Drum Circle 120 PAX

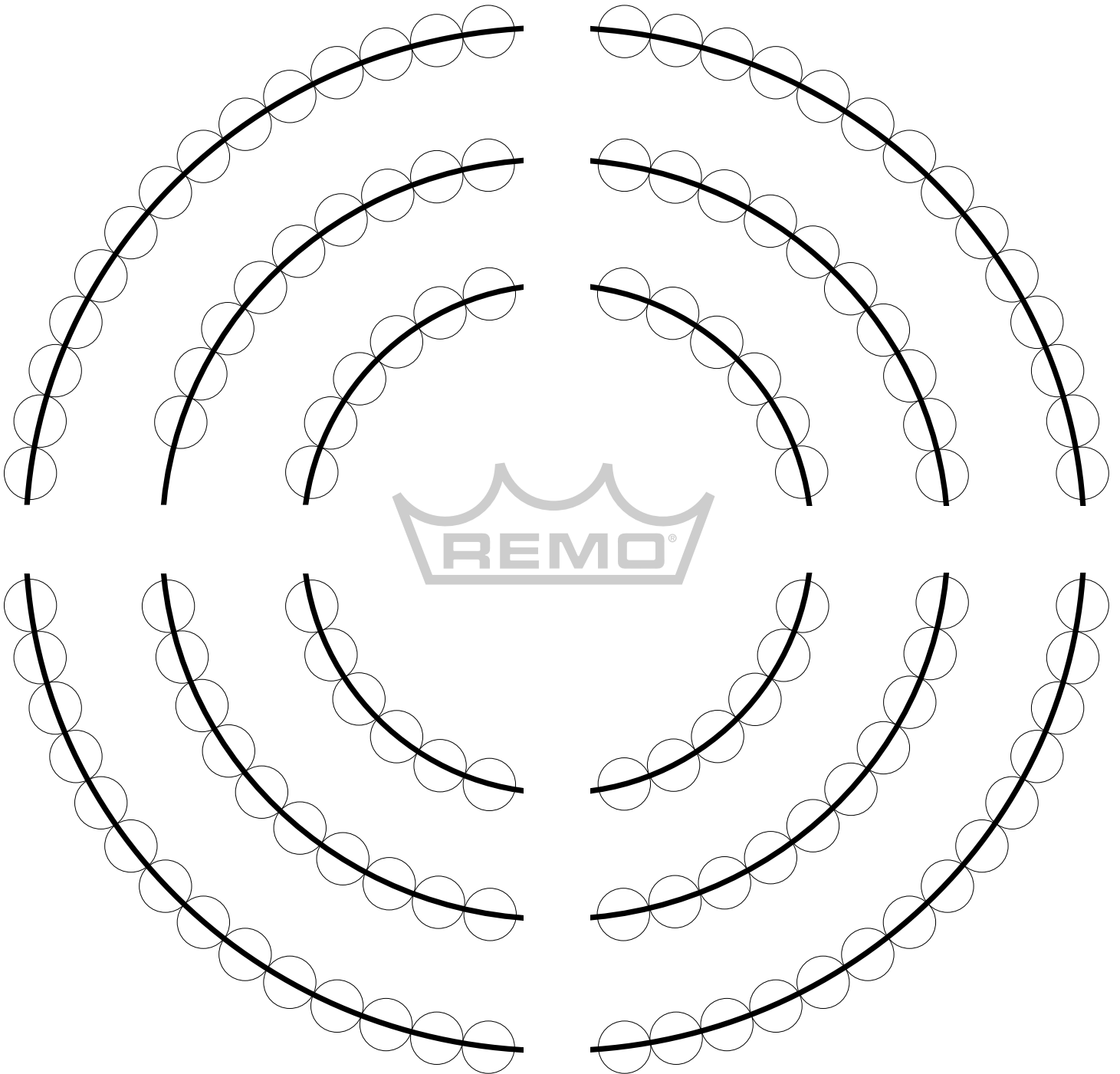

Drum Circle 124 PAX

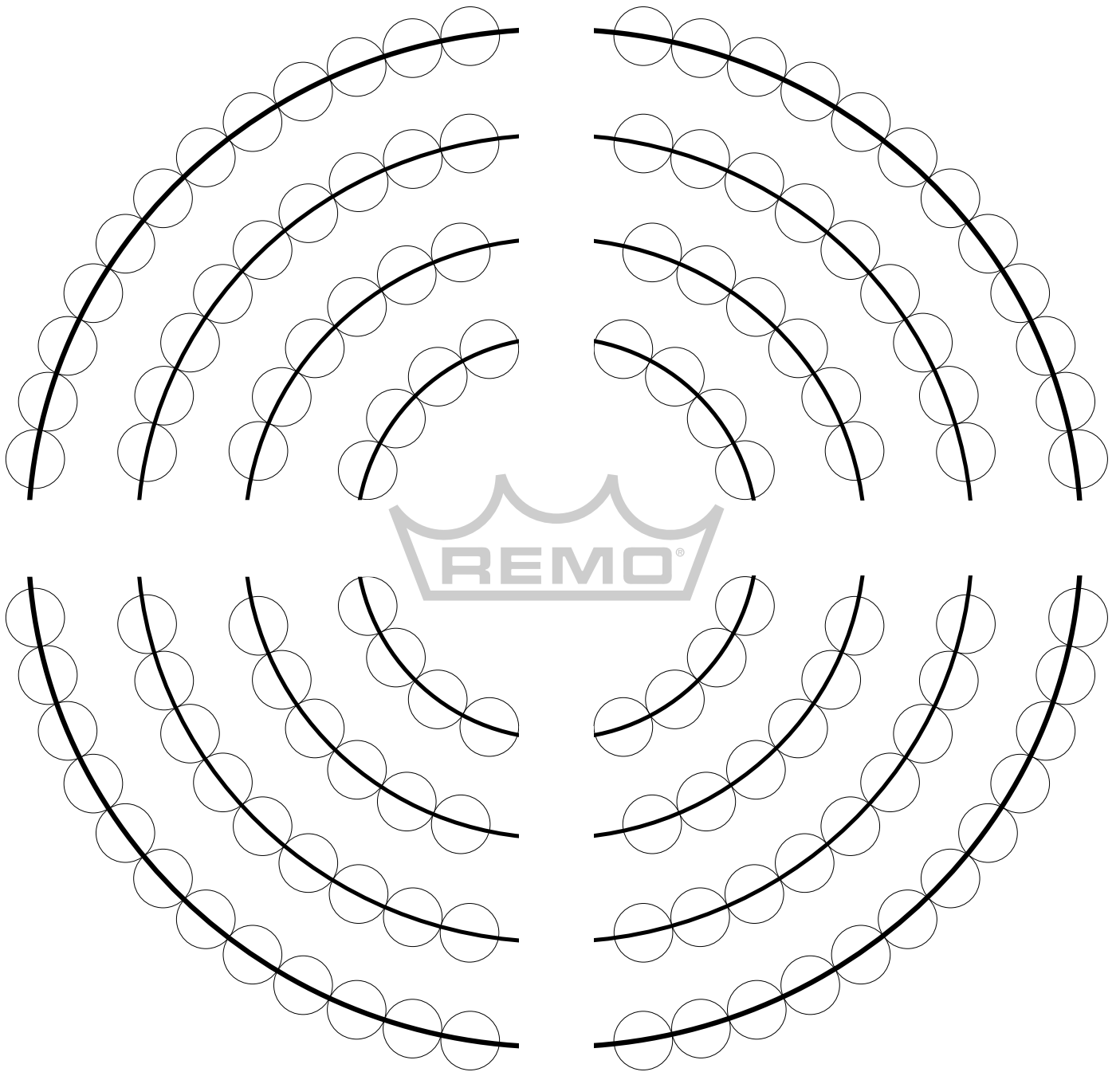

Drum Circle 156 PAX

